

TSM35-075-22-5V-050A-LW4



- Permanent Magnet Stepper Motor
- Precise Motion at a Low Cost
- 550 g-cm of Torque
- 35 mm diameter
- Can be customized for
 - winding current to optimize torque
 - shaft options
 - cables or connectors

Specifications

Item	Specifications
Step Angle Accuracy	±8% (full step, no load)
Resistance Accuracy	±10%
Inductance Accuracy	±20%
Temperature Rise	80° C Max
Ambient Temperature	-20°C to +50°C
Insulation Resistance	100MOMin. ,500VDC
Dielectric Strength	500VAC for one minute
Shaft Radial Play	0.06Max. (450 g-load)
Shaft Axial Play	0.08Max. (450 g-load)

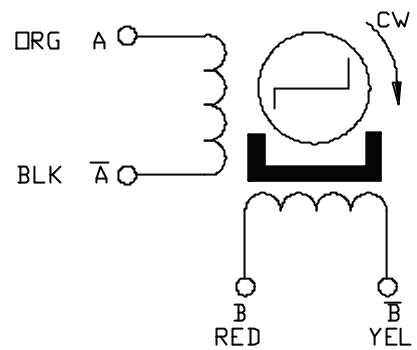

Model	Step Angle (deg)	# of Wires	Voltage (V)	Current per Phase (A)	Resistance Per Phase (ohms)	Holding Torque (g.cm)	Detent Torque (g.cm)	Rotor Inertia (g.cm ²)
TSM35-075-22-5V-050A-LW4	7.5	4	5	0.50	10	550	125	7.5

